

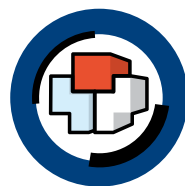

**EINZIGARTIG UND
FLEXIBEL ZUGLEICH**

(f) FLUHR
DISPLAYS

Weil unsere Lösungen verkaufen.

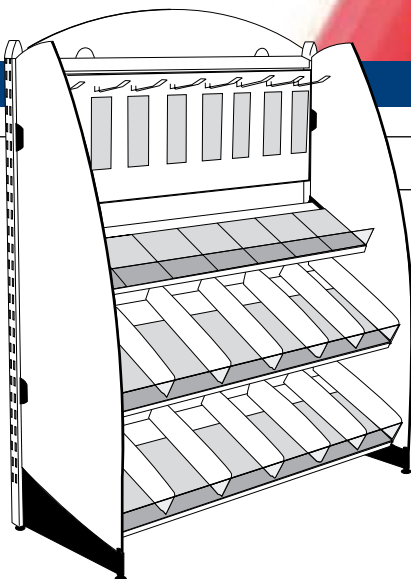

multi FACE
Präsentationssystem



Wir entwickeln Displaylösungen bis ins kleinste Detail – von dekorativen Abschlüssen bis hin zum edlen Standfuß.



Immer bereit – die individuell positionierbaren und unterschiedlichsten Warenträger sorgen für ein flexibles Präsentationssystem.

SO INDIVIDUELL KANN FLEXIBILITÄT SEIN!



> >

Das flexible und individuelle Konzept des multi FACE Display-systems steht für kreative Warenpräsentation am POS. Nicht nur in punkto Design, sondern auch in seiner vielseitigen Anwendung überzeugt multi FACE.

Egal, in welcher Branche Sie auch sind – das multi FACE System präsentiert Sie und Ihr Produkt immer im richtigen Licht. Klare Linien im Design und schlichte Formen setzen Ihr Produkt in den Mittelpunkt.



Immer im Rampenlicht – mit der passenden Beleuchtung setzen Sie Ihr Produkt erst richtig in Szene.



Spielend leicht: Ein genormter Schlitzrahmen sorgt für Flexibilität und Einsatzvariationen.



ZEIGEN SIE WAS SIE HABEN UND WER SIE SIND!

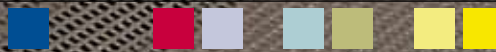

> > Ganz gleich für welche Produkte Sie das multi FACE Displaysystem benötigen, mit den abgestimmten Einsätzen und Warenträgern, dem geschlitzten Rahmen sowie dem Zubehör ermöglicht es einen optimalen Einsatz in allen Bereichen. Auf Wunsch können Sie das multi FACE System auch individuell auf Ihr Erscheinungsbild anpassen.

> > Mit dem multi FACE Displaysystem setzen Sie neue Maßstäbe in der Positionierung und Präsentation Ihrer Produkte. Egal, ob als Standardlösung oder als Sonderentwicklung – Setzen Sie Zeichen, ganz nach dem Motto „Innovation contra Masse“.

FLUHR DISPLAYS – weil unsere Lösungen verkaufen.



> > Mit der dramaturgisch richtig umgesetzten Präsentation am Point of Sale ziehen Sie die Blicke auf sich und setzen Zeichen. Entscheidend für die richtige Inszenierung ist die flexible und individuell anpassbare Warenpräsentation. Egal, welche Produkte Sie zeigen, ob Küchenzubehör, Bücher, Glückwunschkarten oder Merchandiseartikel, das multi Face System hat stets eine Lösung parat. Nicht nur, dass es variabel in seiner Bestückung ist, es lässt sich auch spielend an jede Räumlichkeit anpassen. Überzeugen Sie sich doch einfach selbst.



WIR SETZEN SIE RICHTIG IN SZENE!



ANDERE FARBEN – ANDERE FORMEN

Das multi FACE Displaysystem bringt mehr Stil und Flexibilität in Ihre Warenpräsentation. Neben den Standardlösungen entwickeln wir gerne Ihr individuelles multi FACE Display nach Ihren Wünschen und Farben.



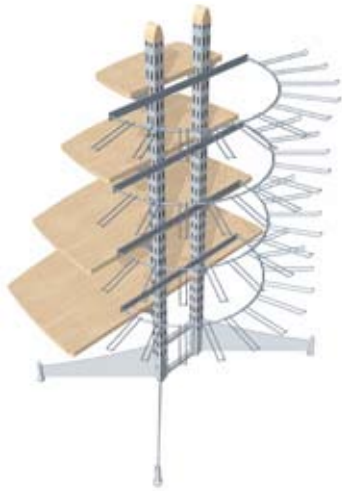

Musteraufbau multi FACE

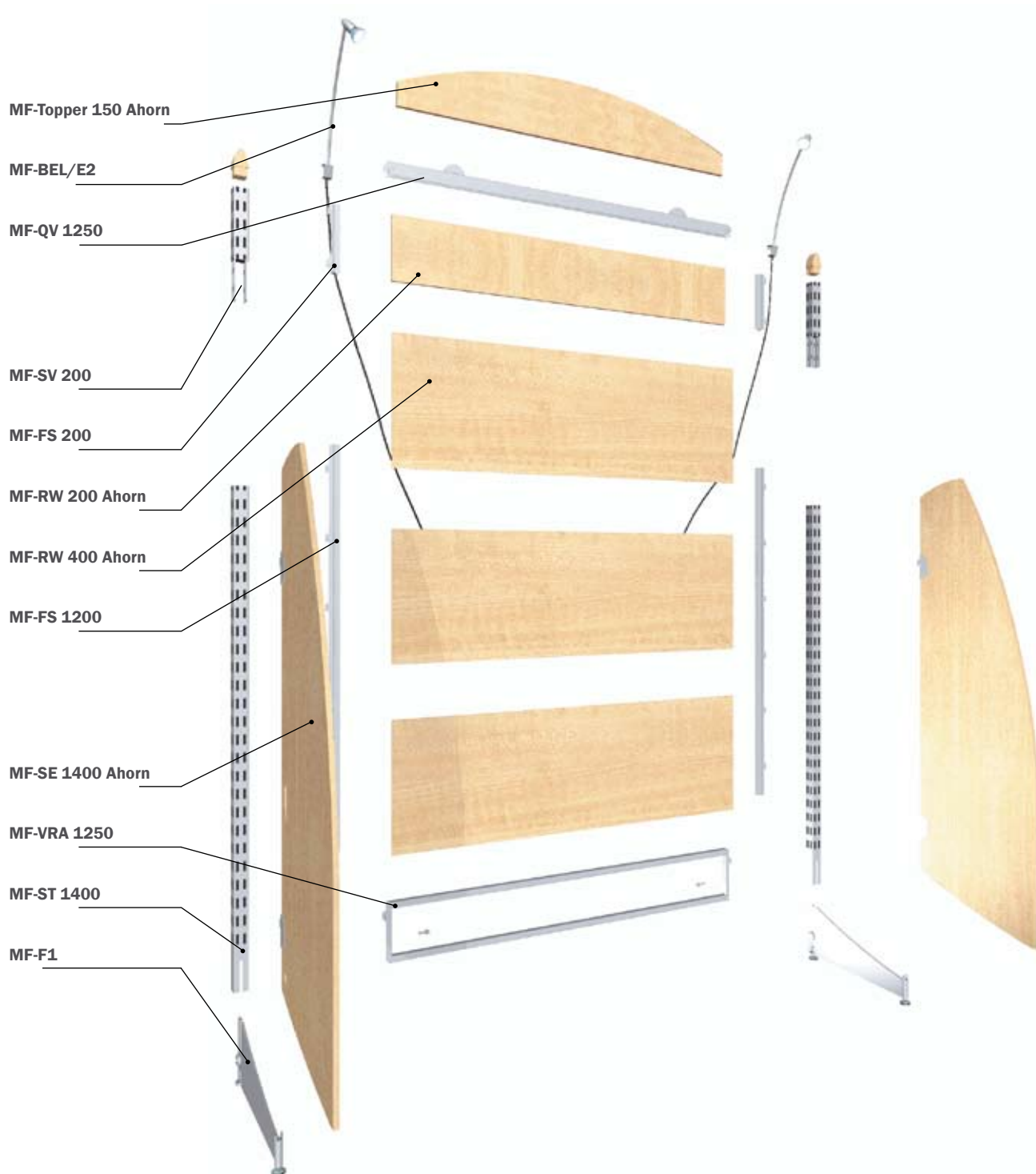

Technische Änderungen vorbehalten!

STANDARD-FARBE

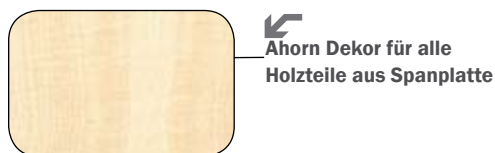
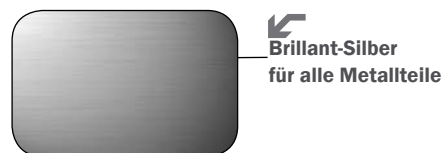

SONDERFARBEN

>> Es sind eine Vielzahl von RAL-Farben und Holzdekor für Sonderanfertigung möglich – Fragen Sie danach!



Eine kleine Auswahl der möglichen RAL-Sonderfarben und Holzdekor für Sonderlösungen.

Systemmaße Standrohr

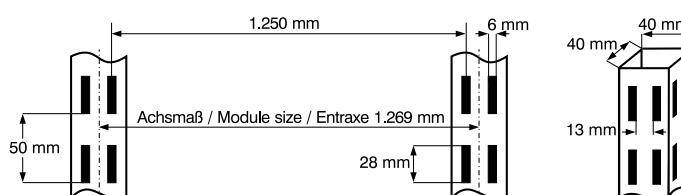

Systemmaße Lochblechrückwand

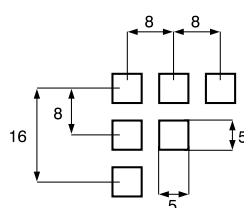

Systemmaße Lamellenrückwand

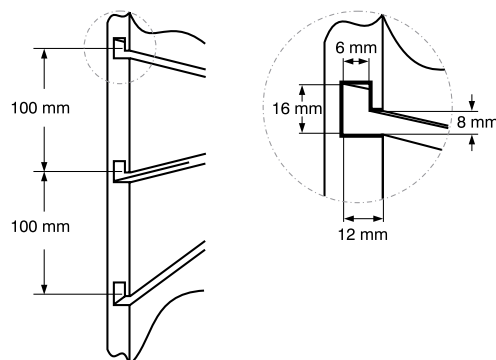

FLEXIBILITÄT PUR

Stellen Sie einfach und schnell Ihr eigenes multi FACE Display für Ihre Produkte zusammen.

1. Grundgestell auswählen
2. Warenträger auswählen
3. Zubehör und Design auswählen
4. Menge festlegen
5. Bestellen

Grundgestell, einseitig | MF-G 1250/1

Farbe: ■ Brillant-Silber



> >

MF-G 1250/1 | Art.Nr. 101 200 900 | Abmessung: 1305B x 510T x 1460H mm

MF-G 1000/1 | Art.Nr. 101 201 760 | Abmessung: 1055B x 510T x 1460H mm

MF-G 500/1 | Art.Nr. 101 201 770 | Abmessung: 555B x 510T x 1460H mm

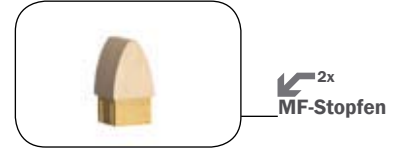
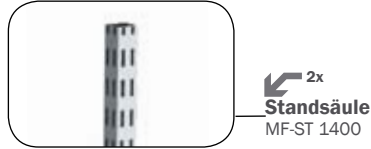

Grundgestell, zweiseitig | MF-G 1250/2

Farbe: ■ Brillant-Silber



> >

MF-G 1250/2 | Art.Nr. 101 200 920 | Abmessung: 1305B x 985T x 1460H mm

MF-G 1000/2 | Art.Nr. 101 201 780 | Abmessung: 1055B x 985T x 1460H mm

MF-G 500/2 | Art.Nr. 101 201 790 | Abmessung: 555B x 985T x 1460H mm

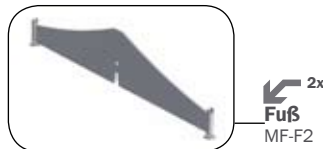

Querverbinder | MF-QV 1250



> >

MF-QV 1250 | Art.Nr. 297 301 430 | Breite: 1250 mm

MF-QV 1000 | Art.Nr. 297 301 690 | Breite: 1000 mm

MF-QV 500 | Art.Nr. 297 301 680 | Breite: 500 mm

TOPPER 150 | maple Dekor



> >

MF-Topper 150/1250 | Art.Nr. 299 900 150 | Abmessung: 1170B x 150H mm

MF-Topper 150/1000 | Art.Nr. 299 900 400 | Abmessung: 920B x 150H mm

MF-Topper 150/500 | Art.Nr. 299 900 410 | Abmessung: 420B x 150H mm

Topper kann nur in Verbindung mit dem jeweiligen Querverbinder MF-QV eingesetzt werden!

Erweiterung Grundgestell, einseitig MF-GER 1250 | 1

Farbe:  Brillant-Silber



> >

MF-GER 1250/1 | Art.Nr. 101 200 910 | Abmessung: 1265B x 510T x 1460H mm

MF-GER 1000/1 | Art.Nr. 101 201 800 | Abmessung: 1015B x 510T x 1460H mm

MF-GER 500/1 | Art.Nr. 101 201 810 | Abmessung: 515B x 510T x 1460H mm

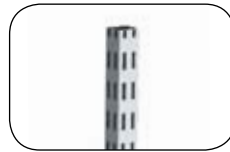

1x
Standsäule
MF-ST 1400



1x
MF-Stopfen



1x
Fuß
MF-F1

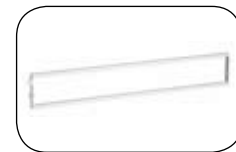

2x
Verbindungsrahmen
MF-VRA

Erweiterung Grundgestell, zweiseitig MF-GER 1250 | 2

Farbe:  Brillant-Silber



> >

MF-GER 1250/2 | Art.Nr. 101 200 930 | Abmessung: 1265B x 985T x 1460H mm

MF-GER 1000/2 | Art.Nr. 101 201 820 | Abmessung: 1015B x 985T x 1460H mm

MF-GER 500/2 | Art.Nr. 101 201 830 | Abmessung: 515B x 985T x 1460H mm

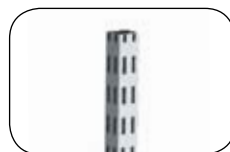

1x
Standsäule
MF-ST 1400



1x
MF-Stopfen



1x
Fuß
MF-F2

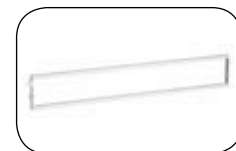

2x
Verbindungsrahmen
MF-VRA

Säulenverlängerung | MF-SV 200 | 400



> >

MF-SV 200 | Art.Nr. 239 900 180 | Höhe: 200 mm

MF-SV 400 | Art.Nr. 239 900 170 | Höhe: 400 mm

Holzstopfen | maple Dekor



> >

MF-Stopfen | Art.Nr. 563 200 190

Grundgestell, einseitig, mit Holzrückwand und Topper | MF-G 1250 | 1 | Maple

Farbe: ■ Brillant-Silber ■ Ahorn Dekor



MF-G 1250/1/Ahorn | Art.Nr. 101 200 940 | Abmessung: 1305B x 510T x 1565H mm

MF-G 1000/1/Ahorn | Art.Nr. 101 201 840 | Abmessung: 1055B x 510T x 1565H mm

MF-G 500/1/Ahorn | Art.Nr. 101 201 850 | Abmessung: 555B x 510T x 1565H mm



2x
Standsäule
MF-ST 1400



2x
MF-Stopfen



1x
Querverbinder
MF-QV



1x
MF-Topper



2x
Fuß
MF-F1



2x
Schiene
MF-FS 1200

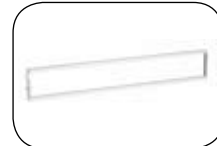

1x
Verbindungsrahmen
MF-VRA



3x
Rückwand Ahorn
MF-RW

Grundgestell, zweiseitig, mit Holzrückwand und Topper | MF-G 1250 | 2 | Ahorn

Farbe: ■ Brillant-Silber ■ Ahorn Dekor



MF-G 1250/2/maple | Art.Nr. 101 200 960 | Abmessung: 1305B x 985T x 1565H mm

MF-G 1000/2/maple | Art.Nr. 101 201 860 | Abmessung: 1055B x 985T x 1565H mm

MF-G 500/2/maple | Art.Nr. 101 201 870 | Abmessung: 555B x 985T x 1565H mm



2x
Standsäule
MF-ST 1400



2x
MF-Stopfen

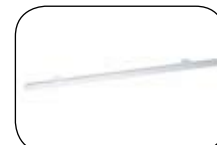

1x
Querverbinder
MF-QV



1x
MF-Topper



2x
Fuß
MF-F2



2x
Schiene
MF-FS 1200

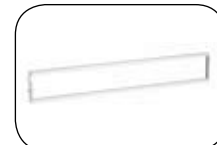

1x
Verbindungsrahmen
MF-VRA



3x
Rückwand Ahorn
MF-RW

Aufsatz Grundgestell, mit Holzrückwand MF-GA 1250 | 200 | Ahorn



MF-GA 1250/200/maple | Art.Nr. 101 200 980 | Abmessung: 1250B x 200H mm

MF-GA 1000/200/maple | Art.Nr. 101 201 880 | Abmessung: 1000B x 200H mm

MF-GA 500/200/maple | Art.Nr. 101 201 890 | Abmessung: 500B x 200H mm

Aufsatz Grundgestell, mit Holzrückwand MF-GA 1250 | 400 | Ahorn



MF-GA 1250/400/maple | Art.Nr. 101 201 000 | Abmessung: 1250B x 400H mm

MF-GA 1000/400/maple | Art.Nr. 101 201 900 | Abmessung: 1000B x 400H mm

MF-GA 500/400/maple | Art.Nr. 101 201 910 | Abmessung: 500B x 400H mm

Erweiterung Grundgestell, einseitig, mit Holzrückwand und Topper MF-GER 1250 | 1 | Ahorn

Farbe: ■ Brillant-Silber ■ Ahorn Dekor



> >

MF-GER 1250/1/Ahorn | Art.Nr. 101 200 950 | Abmessung: 1265B x 510T x 1565H mm

MF-GER 1000/1/Ahorn | Art.Nr. 101 201 920 | Abmessung: 1015B x 510T x 1565H mm

MF-GER 500/1/Ahorn | Art.Nr. 101 201 930 | Abmessung: 515B x 510T x 1565H mm



1x
Standsäule
MF-ST 1400



1x
MF-Stopfen



1x
Querverbinder
MF-QV



1x
MF-Topper



1x
Fuß
MF-F1



2x
Schiene
MF-FS 1200

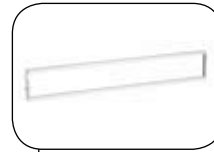

1x
Verbindungsrahmen
MF-VRA



3x
Rückwand Ahorn
MF-RW

Erweiterung Grundgestell, zweiseitig, mit Holzrückwand und Topper MF-GER 1250 | 2 | Ahorn

Farbe: ■ Brillant-Silber ■ Ahorn Dekor



> >

MF-GER 1250/2/Ahorn | Art.Nr. 101 200 970 | Abmessung: 1265B x 985T x 1565H mm

MF-GER 1000/2/Ahorn | Art.Nr. 101 201 940 | Abmessung: 1015B x 985T x 1565H mm

MF-GER 500/2/Ahorn | Art.Nr. 101 201 950 | Abmessung: 515B x 985T x 1565H mm



1x
Standsäule
MF-ST 1400



1x
MF-Stopfen

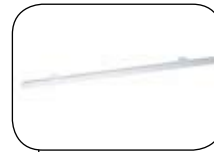

1x
Querverbinder
MF-QV

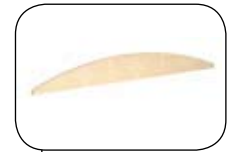

1x
MF-Topper



1x
Fuß
MF-F2



2x
Schiene
MF-FS 1200

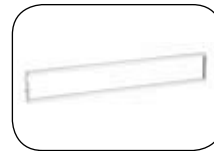

1x
Verbindungsrahmen
MF-VRA

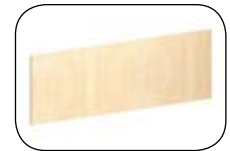

3x
Rückwand Ahorn
MF-RW

Erweiterung Aufsatz Grundgestell, mit Holzrückwand

MF-GAER 1250 | 200 | Ahorn

> >

MF-GAER 1250/200/Ahorn | Art.Nr. 101 200 990 | Abmessung: 1250B x 200H mm

MF-GAER 1000/200/Ahorn | Art.Nr. 101 201 960 | Abmessung: 1000B x 200H mm

MF-GAER 500/200/Ahorn | Art.Nr. 101 201 970 | Abmessung: 500B x 200H mm



Erweiterung Aufsatz Grundgestell, mit Holzrückwand

MF-GAER 1250 | 400 | Ahorn

> >

MF-GAER 1250/400/Ahorn | Art.Nr. 101 201 010 | Abmessung: 1250B x 400H mm

MF-GAER 1000/400/Ahorn | Art.Nr. 101 201 980 | Abmessung: 1000B x 400H mm

MF-GAER 500/400/Ahorn | Art.Nr. 101 201 990 | Abmessung: 500B x 400H mm





Grundgestell, einseitig, Lamellenrückwand

MF-G/LAM 1250 | 1 | Ahorn

Farbe: ■ Brillant-Silber ■ Ahorn Dekor



Erweiterung Grundgestell, einseitig, Lamellenrückwand MF-GER/LAM 1250 | 1 | Ahorn

Farbe: ■ Brillant-Silber ■ Ahorn Dekor



Aufsatz Grundgestell, Lamellenrückwand

MF-GA/LAM 1250 | 200 | 400 | Ahorn



Erweiterung Aufsatz Grundgestell, Lamellenrückwand

MF-GAER/LAM 1250 | 200 | 400 | Ahorn



> >

MF-G/LAM 1250/1/Ahorn | Art.Nr. 101 201 020 | Abmessung: 1305B x 510T x 1565H mm

MF-G/LAM 1000/1/Ahorn | Art.Nr. 101 202 000 | Abmessung: 1055B x 510T x 1565H mm

MF-G/LAM 500/1/Ahorn | Art.Nr. 101 202 010 | Abmessung: 555B x 510T x 1565H mm



2x
Standsäule
MF-ST 1400



2x
MF-Stopfen

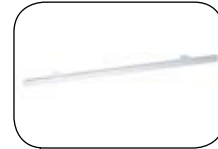

1x
Querverbinder
MF-QV



1x
MF-Topper



2x
Fuß
MF-F1



2x
Schiene
MF-FS 1200

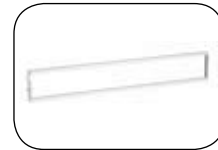

1x
Verbindungsrahmen
MF-VRA



3x
Rückwand Lamelle
MF-LAM

> >

MF-GER/LAM 1250/1/Ahorn | Art.Nr. 101 201 030 | Abmessung: 1265B x 510T x 1565H mm

MF-GER/LAM 1000/1/Ahorn | Art.Nr. 101 202 020 | Abmessung: 1015B x 510T x 1565H mm

MF-GER/LAM 500/1/Ahorn | Art.Nr. 101 202 030 | Abmessung: 515B x 510T x 1565H mm



1x
Standsäule
MF-ST 1400



1x
MF-Stopfen

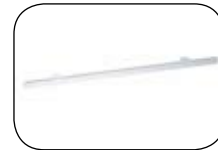

1x
Querverbinder
MF-QV



1x
MF-Topper



1x
Fuß
MF-F1



2x
Schiene
MF-FS 1200

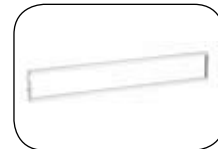

1x
Verbindungsrahmen
MF-VRA



3x
Rückwand Lamelle
MF-LAM

> >

HÖHE: 200

HÖHE: 400

MF-GA/LAM 1250/200/Ahorn | Art.Nr. 101 201 040 | 1250/400 | Art.Nr. 101 201 060

MF-GA/LAM 1000/200/Ahorn | Art.Nr. 101 202 040 | 1000/400 | Art.Nr. 101 202 060

MF-GA/LAM 500/200/Ahorn | Art.Nr. 101 202 050 | 500/400 | Art.Nr. 101 202 070

> >

HÖHE: 200

HÖHE: 400

MF-GAER/LAM 1250/200/Ahorn | Art.Nr. 101 201 050 | 1250/400 | Art.Nr. 101 201 070

MF-GAER/LAM 1000/200/Ahorn | Art.Nr. 101 202 080 | 1000/400 | Art.Nr. 101 202 100

MF-GAER/LAM 500/200/Ahorn | Art.Nr. 101 202 090 | 500/400 | Art.Nr. 101 202 110

Durch abgestimmte Warenträger, Körbe, Lochblechrückwände und dem Zubehör sind Sie immer flexibel und können Ihr Display individuell zusammenstellen. Ob Sie viel „Ladefläche“ oder Platz für „Hänge-ware“ benötigen – das multi FACE System ist enorm vielseitig.

Einfach die gewünschte Kombination auswählen, die Warenträger einhängen und fertig.

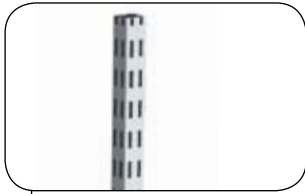

↙
Standsäule MF-ST 1400
Art.Nr. 237 040 010



↙
Standfuß einseitig MF-F 1
Art.Nr. 297 900 920

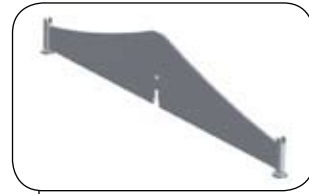

↙
Standfuß zweiseitig MF-F 2
Art.Nr. 297 900 910



↙
Querverbinder
MF-QV 1250 | Art.Nr. 297 301 430
MF-QV 1000 | Art.Nr. 297 301 690
MF-QV 500 | Art.Nr. 297 301 680

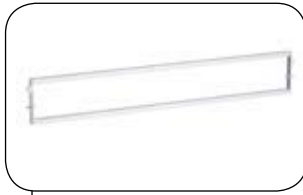

↙
Verbindungsrahmen
MF-VRA 1250 | Art.Nr. 222 400 620
MF-VRA 1000 | Art.Nr. 222 400 690
MF-VRA 500 | Art.Nr. 222 400 680



↙
Topper Ahorn
MF-Topper 150/1250 | Art.Nr. 299 900 150
MF-Topper 150/1000 | Art.Nr. 299 900 400
MF-Topper 150/500 | Art.Nr. 299 900 410



↙
Holzstopfen MF-Stopfen
Art.Nr. 563 200 190

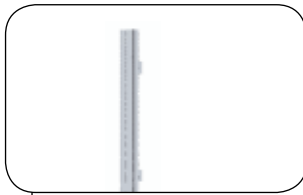

↙
Führungsschiene
MF-FS 1200 | Art.Nr. 297 301 460
MF-FS 400 | Art.Nr. 297 301 450
MF-FS 200 | Art.Nr. 297 301 440

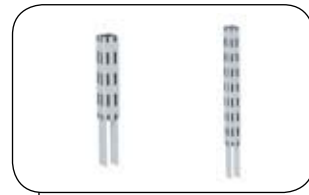

↙
Säulenverlängerung
MF-SV 200 | Art.Nr. 239 900 180
MF-SV 400 | Art.Nr. 239 900 170

↙
Holzrückwand Ahorn | MF-RW



- > > ↙ **HÖHE: 200** ↙ **HÖHE: 400**
MF-RW 200/1250 | Art.Nr. 299 900 190 | MF-RW 400/1250 | Art.Nr. 299 900 180
MF-RW 200/1000 | Art.Nr. 299 900 440 | MF-RW 400/1000 | Art.Nr. 299 900 420
MF-RW 200/500 | Art.Nr. 299 900 450 | MF-RW 400/500 | Art.Nr. 299 900 430

↙
Lamellenrückwand Ahorn | MF-LAM



- > > ↙ **HÖHE: 200** ↙ **HÖHE: 400**
MF-LAM 200/1250 | Art.Nr. 299 900 220 | MF-LAM 400/1250 | Art.Nr. 299 900 210
MF-LAM 200/1000 | Art.Nr. 299 900 630 | MF-LAM 400/1000 | Art.Nr. 299 900 610
MF-LAM 200/500 | Art.Nr. 299 900 640 | MF-LAM 400/500 | Art.Nr. 299 900 620



↙
Seitenteil Ahorn
MF-SE 1400/Ahorn
Art.Nr. 296 500 010



↙
Beleuchtung
MF-BEL/E2
Art.Nr. 299 000 470
je Set 2 Lampen

↙
Lochblechrückwand | MF-LW

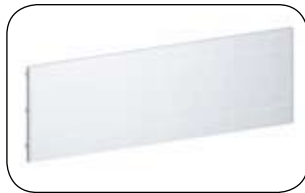

> >

↙ **HÖHE: 200**

↙ **HÖHE: 400**

MF-LW 200/1250 | **Art.Nr. 297 000 920** | MF-LW 400/1250 | **Art.Nr. 297 000 930**
MF-LW 200/1000 | **Art.Nr. 297 001 020** | MF-LW 400/1000 | **Art.Nr. 297 001 030**
MF-LW 200/500 | **Art.Nr. 297 001 000** | MF-LW 400/500 | **Art.Nr. 297 001 010**



↙
Lochblechetage 300
MF-LBE 300/1250
Art.Nr. 267 000 220
MF-LBE 300/1000
Art.Nr. 267 000 300
MF-LBE 300/500
Art.Nr. 267 000 270



↙
Lochblechetage 410
MF-LBE 410/1250
Art.Nr. 267 000 210
MF-LBE 410/1000
Art.Nr. 267 000 290
MF-LBE 410/500
Art.Nr. 267 000 280

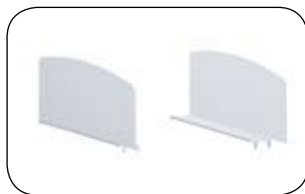

↙
Fachteiler 300
MF-FT/LBE 300
Art.Nr. 297 301 490
je Set 2 Fachteiler

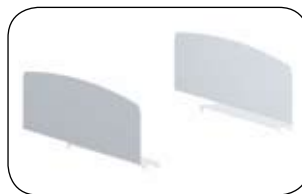

↙
Fachteiler 410
MF-FT/LBE 410
Art.Nr. 297 301 500
je Set 2 Fachteiler



↙
Schlaufenhaken 120
MF-LWH 120/2
Art.Nr. 292 800 700
je Set 20 St. | Nutzlänge 115 mm

↙
Schlaufenhaken 200
MF-LWH 200/2
Art.Nr. 292 800 710
je Set 20 St. | Nutzlänge 195 mm



↙
Spitzhaken 120
MF-LWH 120/1
Art.Nr. 292 800 720
je Set 20 St. | Nutzlänge 105 mm

↙
Spitzhaken 200
MF-LWH 200/1
Art.Nr. 292 800 730
je Set 20 St. | Nutzlänge 185 mm

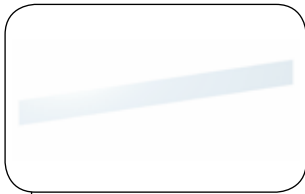

↙
Frontblende Acryl
MF-FBL 1250 Acryl | Art.Nr. 299 900 160
MF-FBL 1000 Acryl | Art.Nr. 299 900 380
MF-FBL 500 Acryl | Art.Nr. 299 900 370



↙
Multifunktionsetage
MF-MFE 1250 | Art.Nr. 264 000 300
MF-MFE 1000 | Art.Nr. 264 000 360
MF-MFE 500 | Art.Nr. 264 000 370



↙
Fachteiler Multifunktionsetage
MF-FT/MFE | Art.Nr. 297 301 480

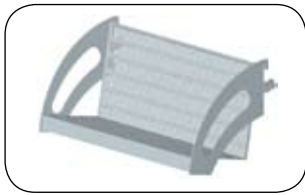

↙
Bücheretage 200
MV-BE 200/500
Art.Nr. 267 000 260

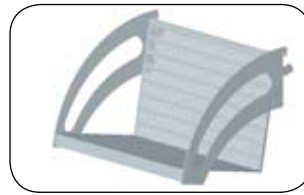

↙
Bücheretage 300
MV-BE 300/500
Art.Nr. 267 000 250

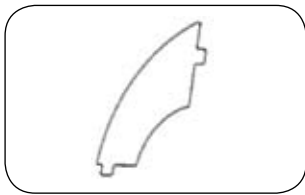

↙
Fachteiler Bücheretage 200
MV-BEF 200/500
Art.Nr. 292 901 071

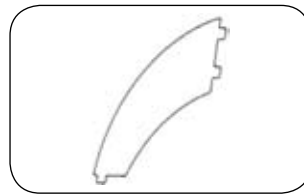

↙
Fachteiler Bücheretage 300
MV-BEF 300/500
Art.Nr. 292 901 081

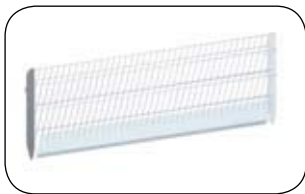

↙
3-stufiger Kartenaufsatz
MF-GKA 1250/3
Art.Nr. 266 100 460
MF-GKA 1000/3
Art.Nr. 266 100 490



↙
8-stufige Kartentreppe
MF-GKT 1250/8
Art.Nr. 266 100 450
MF-GKT 1000/8
Art.Nr. 266 100 500



↙
Vorratsschrank Ahorn Dekor
MF-VOS 1250/Ahorn
Art.Nr. 299 900 240
MF-VOS 1000/Ahorn
Art.Nr. 299 900 570



↙
Blende Ahorn Dekor
MF-FBL 1250/Ahorn
Art.Nr. 299 900 200
MF-FBL 1000/Ahorn
Art.Nr. 299 900 390



↙
Gitterkorb
MV-KE 360/500
Art.Nr. 264 000 320



↙
Lochblechetage Lamelle
MF-LAME 270
Art.Nr. 267 000 230



↙
Blende Acryl
MF-FBL 270 Acryl
Art.Nr. 299 900 230

ZUBEHÖR UND EXTRAS

Zu Stil, Funktionalität und Design hat jeder seine ganz eigenen Vorstellungen. Deshalb bieten wir Ihnen eine große Palette an individuellem Designzubehör, das wir speziell auf Ihre Anforderungen anpassen.

Für fast jeden Zweck bietet das multi FACE System die unterschiedlichsten Einsätze und Haken – Fragen Sie danach!





Viele Extras auf Anfrage möglich





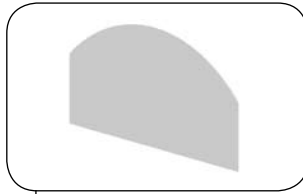

Grundgestell
 MV-G | Art.Nr.128 000 160
Abmessung: 550B x 580T x 1260H mm

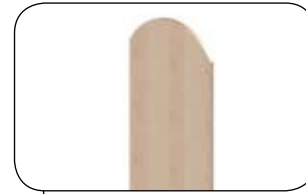

Topper Acryl
 MV-Topper Acryl
Art.Nr. 299 900 360
Abmessung: 470B x 180H mm



Rückwand Ahorn Dekor
 MV-RW 400 Ahorn
Art.Nr. 296 500 020
Abmessung: 400B x 1130H mm



Lochblechrückwand 400
 MF-LW 400/500
Art.Nr. 297 001 010
Abmessung: 500B x 400H mm
 max. 2x pro Grundgestell möglich





Lochblechrückwand 200
 MF-LW 200/500
Art.Nr. 297 001 000
Abmessung: 500B x 200H mm
 max. 5x pro Grundgestell möglich





Gitterkorb | MV-KE 360/500
Art.Nr. 264 000 320
Abmessung: 490B x 360T x 80H mm
 max. 4x pro Grundgestell möglich

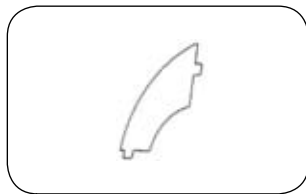



Bücheretage klein 200
 MF-BE 200/500 | **Art.Nr. 267 000 260**
Abmessung: 490B x 150T x 200H mm
 max. 4x pro Grundgestell möglich





Fachteiler Bücheretage klein
 MV-BEF 200/500 | **Art.Nr. 292 901 070**
Abmessung: 150T x 200H mm

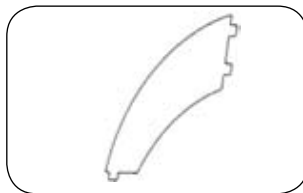

Bücheretage groß 300
 MF-BE 300/500 | **Art.Nr. 267 000 250**
Abmessung: 490B x 250T x 300H mm
 max. 3x pro Grundgestell möglich



Fachteiler Bücheretage groß
 MV-BEF 300/500 | **Art.Nr. 292 901 080**
Abmessung: 250T x 300H mm



Lochblechetage 300 | MF-LBE 300/500
Art.Nr. 267 000 270
Abmessung: 490B x 300T mm
 max. 4x pro Grundgestell möglich



Fachteiler 300 | MF-FT/LBE 300
Art.Nr. 297 301 490
Abmessung: 270T x 80H mm
 je Set ein linker & rechter Fachteiler



Lochblechetage 410 | MF-LBE 410/500
Art.Nr. 267 000 280
Abmessung: 490B x 410T mm
 max. 4x pro Grundgestell möglich





Fachteiler 410 | MF-FT/LBE 410
Art.Nr. 297 301 500
Abmessung: 410T x 80H mm
 je Set ein linker & rechter Fachteiler

MULTI FACE PYRAMIDE

Mittelraum Pyramide | MFP-MR

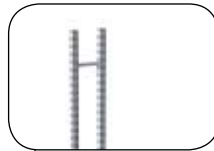

> > **MFP-MR | Art.Nr. 199 000 760** | Abmessung: 1200B x 1200T x 1430H mm



1x
Standsäule
MFP-SR 1400

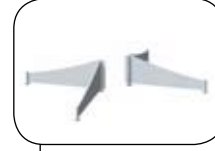

1x
Fuß
MFP-FG 2



1x
Holzetape
MFP-E 450x450



2x
Holzetape
MFP-E 700x350



2x
Holzetape
MFP-E 950x475



2x
Holzetape
MFP-E 1200x600

Wandlösung Pyramide | MFP-W



> > **MFP-W | Art.Nr. 199 000 770** | Abmessung: 950B x 515T x 1460H mm

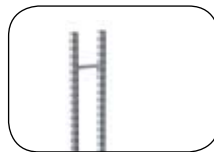

1x
Standsäule
MFP-SR 1400



1x
Fuß
MFP-FG 1

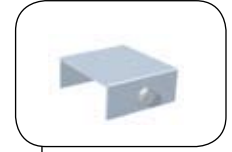

1x
MFP-Wandhalter



2x
Holzetape
MFP-E 700x350



2x
Holzetape
MFP-E 950x475



1x
Standfuß einseitig
MF-FG 1
Art. Nr. 297 900 942
je Set 2 St.



1x
Standfuß zweiseitig
MF-FG 2
Art. Nr. 297 900 931
je Set 2 St.

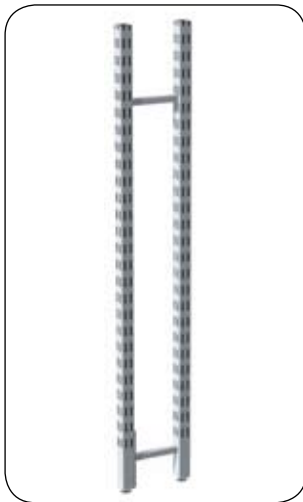

↙
Standsäule
MFP-SR 1400
Art. Nr. 222 400 640

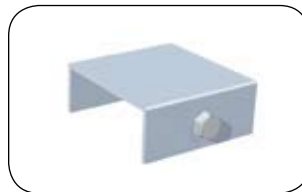

↙
MFP-Wandhalter
Art. Nr. 297 301 510



↙
Holzetage
MFP-E 450x450
Art. Nr. 269 900 150
Abmessung:
450B x 450T mm



↙
Holzetage
MFP-E 950x475
Art. Nr. 269 900 130
Abmessung:
950B x 475T mm



↙
Holzetage
MFP-E 700x350
Art. Nr. 269 900 120
Abmessung:
700B x 350T mm



↙
Holzetage
MFP-E 1200x600
Art. Nr. 269 900 140
Abmessung:
1200B x 600T mm



↙
Säulenverlängerung
MF-SV 200
Art. Nr. 239 900 180



↙
Säulenverlängerung
MF-SV 400
Art. Nr. 239 900 170

EIN KLEINER ÜBERBLICK UNSERER LÖSUNGEN

> > **Unsere Displaylösungen hinterlassen farbenfrohe Spuren in allen Handelsbereichen.**

Egal, ob Sie ein speziell für Sie entwickeltes Display oder eine Standardlösung benötigen – wir kennen die Branchen. Und genau aus diesem Grund können wir für Sie neue Akzente setzen. Lassen Sie uns gemeinsam neue Wege am POS gehen. Weitere Informationen über unser breit gefächertes Displayprogramm finden Sie in unseren weiteren Prospekten oder direkt bei unseren Kundenberatern – Fragen Sie uns danach.



multi VAN



multi DESIGN



ELOS

DER TAGESSPIEGEL
ZEITUNG FÜR BERLIN UND DEUTSCHLAND



DUMONT **monte**

LEGO
LEGOLAND
DEUTSCHLAND



Die gute Karte

ARTEBENE



Wir haben die Technik.
Sie das Vergnügen.



GEFU
GENIAL GENIESSEN

sigel®

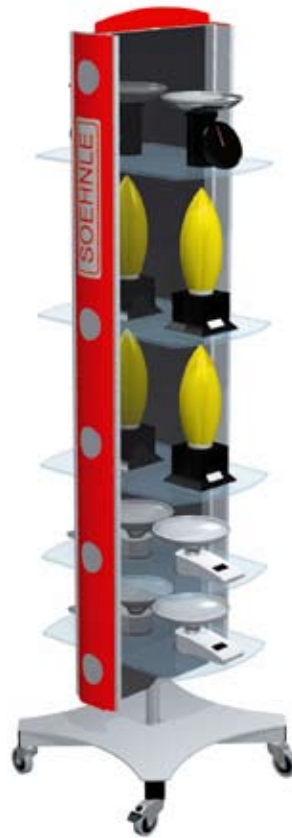

ZWILLING
J.A.HENCKELS





FLUHR DISPLAYS e.K.

Buschelbergstraße 4 | 86850 Fischach

Fon. +49[0]8236.585-0 | Fax. +49[0]8236.585-50

info@fluhr-displays.de | www.fluhr-displays.de